





Frontenkollektion



Preisgruppe 1

	... A Weiß glänzend melaminharzbeschichtet 4-seitig mit Laserkante Empfohlener Korpus: Weiß glänzend A		... B Steingrau glänzend melaminharzbeschichtet 4-seitig mit Laserkante Empfohlener Korpus: Steingrau glänzend B		... C Schwarz glänzend melaminharzbeschichtet 4-seitig mit Laserkante Empfohlener Korpus: Schwarz glänzend C
	... D FINELINE Eiche Synchronpore melaminharzbeschichtet 4-seitig mit Laserkante Empfohlener Korpus: Schwarz glänzend C		... E Eiche grau Synchronpore melaminharzbeschichtet 4-seitig mit Laserkante Empfohlener Korpus: Eiche grau E		... F Eiche natur Synchronpore melaminharzbeschichtet 4-seitig mit Laserkante Empfohlener Korpus: Eiche natur F
	... G Kirsche Piemont Synchronpore melaminharzbeschichtet 4-seitig mit Laserkante Empfohlener Korpus: Kirsche Piemont G		... H Eiche dunkel Synchronpore melaminharzbeschichtet 4-seitig mit Laserkante Empfohlener Korpus: Eiche dunkel H		... Q Eiche braun Synchronpore melaminharzbeschichtet 4-seitig mit Laserkante Empfohlener Korpus: Eiche braun Q

Preisgruppe 2

	... I Weiß samt matt Schichtstoff samt matt 4-seitig mit Laserkante Empfohlener Korpus: Weiß matt I		... J Creme samt matt Schichtstoff samt matt 4-seitig mit Laserkante Empfohlener Korpus: Creme matt J		... K Grau samt matt Schichtstoff samt matt 4-seitig mit Laserkante Empfohlener Korpus: Grau matt K
--	--	---	--	--	--









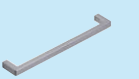

Preisgruppe 3

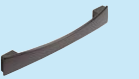
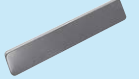

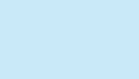

	... L Polyerglas weiß hochglänzend Glaslaminatbeschichtung 4-seitig mit Laserkante Empfohlener Korpus: Weiß glänzend A		... M Polyerglas mint hochglänzend Glaslaminatbeschichtung 4-seitig mit Laserkante Empfohlener Korpus: Eiche natur F		... N Polyerglas anthrazit hochglänzend Glaslaminatbeschichtung 4-seitig mit Laserkante Empfohlener Korpus: Weiß glänzend A
	... O Polyerglas kaschmir hochglänzend Glaslaminatbeschichtung 4-seitig mit Laserkante Empfohlener Korpus: Eiche grau E		... P Schwarz Flash Schichtstoff Poly matt mit Flash-Dekor 4-seitig mit Laserkante Empfohlener Korpus: Schwarz glänzend C		... R Polyerglas schwarz hochglänzend Glaslaminatbeschichtung 4-seitig mit Laserkante Empfohlener Korpus: Schwarz glänzend C

Korpusdekore



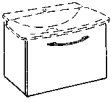
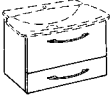



					
... A ... Weiß glänzend	... B ... Steingrau glänzend	... C ... Schwarz glänzend	... E ... Eiche grau	... F ... Eiche natur	... G ... Kirsche Piemont
					
... H ... Eiche dunkel	... I ... Weiß matt	... J ... Creme matt	... K ... Grau matt	... Q ... Eiche braun	

Griffe

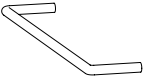
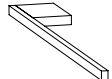

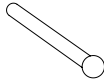



					
... 1 ... Chrom glänzend L = 170 mm ↔ 160 mm	... 2 ... Chrom glänzend L = 170 mm ↔ 160 mm	... 3 ... Chrom glänzend L = 170 mm ↔ 160 mm	... 4 ... Chrom Schwarz glänzend L = 180 mm ↔ 160 mm	... 5 ... Chrom glänzend L = 200 mm ↔ 160 mm	... 6 ... Chrom glänzend L = 172 mm ↔ 160 mm
					
L = 330 mm ↔ 320 mm	L = 330 mm ↔ 320 mm	L = 330 mm ↔ 320 mm	L = 340 mm ↔ 320 mm	L = 332 mm ↔ 320 mm	L = 332 mm ↔ 320 mm

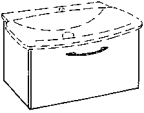
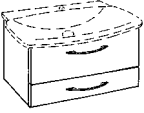
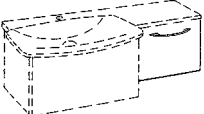
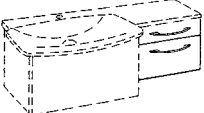
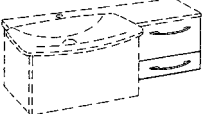
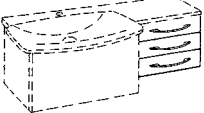



	Höhe in mm	Tiefe in mm	Breite in mm	Type	Griff Korpus Front	Preisgruppen			Beschreibung	
						1	2	3		
	40	405	660	DGWT MG 066 1					Kompaktwaschtisch Mineralgüß weiß glänzend mit Clou-System und Raumspsiphon	
				DGWT MG 066 0					1 Armaturbohrung ohne Armaturbohrung	
				DGWT MG 066 S					Sonderbohrung	
	390	370	590	DGWU A 059	●●●				Waschtisch-Unterschrank für Kompaktwaschtisch 1 Auszug	
	390	370	590	DGWU B 059	●●●				Waschtisch-Unterschrank für Kompaktwaschtisch 1 Auszug mit Siphonausschnitt 1 Schublade	
	40	525	860	DGWT MG 086 1					Einzelwaschtisch Mineralgüß weiß glänzend mit Clou-System und Raumspsiphon	
				DGWT MG 086 0					1 Armaturbohrung ohne Armaturbohrung	
				DGWT MG 086 S					Sonderbohrung	
 <small>Abb. = L</small>	40	525/425	1415	DGWT ML 142 1					Einzelwaschtisch mit Verlängerung Mineralgüß weiß glänzend mit Clou-System und Raumspsiphon	
				DGWT ML 142 0					Becken links, Verlängerung rechts: 1 Armaturbohrung ohne Armaturbohrung	
				DGWT ML 142 S					Sonderbohrung	
	40	525/425	1415	DGWT MR 142 1						Becken rechts, Verlängerung links: 1 Armaturbohrung ohne Armaturbohrung
				DGWT MR 142 0						Sonderbohrung
				DGWT MR 142 S						Sonderbohrung
	40	525	1640	DGWT MD 164 2					Doppelwaschtisch Mineralgüß weiß glänzend mit Clou-System und Raumspsiphon	
				DGWT MD 164 0					2 Armaturbohrungen ohne Armaturbohrungen	
				DGWT MD 164 S					Sonderbohrungen	
Bitte 2 Waschtisch-Unterschränke dazu bestellen!										

dimara® Handtuchhalter (lose beigelegt)

			
Handtuchbügel 357 mm lang, 60 mm tief	Handtuchhalter 380 mm lang, 50 mm tief	Handtuchhalter für Gästewaschtisch 300 mm lang, 50 mm tief	Handtuchhalter für Wandbefestigung 380-700 mm lang, ausziehbar
Z HB CH verchromt 	Z HH 38 verchromt 	Z HH 30 verchromt 	Z HHW 02 CH verchromt 

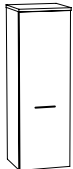
	Höhe in mm	Tiefe in mm	Breite in mm	Type	Griff Korpus Front	Preisgruppen			Beschreibung
						1	2	3	
	390	485	780	DGWU A 078	●●●				Waschtisch-Unterschrank für Einzel- und Doppelwaschtisch 1 Auszug
	390	485	780	DGWU B 078	●●●				Waschtisch-Unterschrank für Einzel- und Doppelwaschtisch 1 Auszug mit Siphonausschnitt 1 Schublade
	390	370	590	DGUS A 059	●●●				Unterschrank für Einzelwaschtisch mit Verlängerung 1 Auszug
	390	370	590	DGUS B 059	●●●				Unterschrank für Einzelwaschtisch mit Verlängerung 1 Schublade 1 Auszug
	390	370	590	DGUS C 059	●●●				Unterschrank für Einzelwaschtisch mit Verlängerung 1 Auszug 1 Schublade
	390	370	590	DGUS D 059	●●●				Unterschrank für Einzelwaschtisch mit Verlängerung 3 Schublade

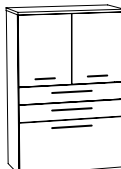
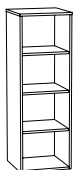
	Höhe in mm	Tiefe in mm	Breite in mm	Type	Griff Korpus Front	Preisgruppen			Beschreibung						
						1	2	3							
	536	390	300	DBUS S A 030 L DBUS S A 030 R	●●●				Unterschrank 1 Tür 1 verstellbarer Glasfachboden						
			400	DBUS S A 040 L DBUS S A 040 R	●●●										
			600	DBUS S A 060 L DBUS S A 060 R	●●●										
	250-450	300-600	DBUS S A XXX L DBUS S A XXX R	●●●									1 Tür 1 verstellbarer Holzfachboden		
			390	800										DBUS S A 080	●●●
			250-450	601-800										DBUS S A XXX	●●●
	536	390	300	DBUS S B 030	●●●				Unterschrank 1 Klapptür mit Wäschekorb						
			400	DBUS S B 040	●●●										
			350-450	300-400	DBUS S B XXX					●●●					
	536	390	300	DBUS S C 030	●●●				Unterschrank 1 Schublade 1 Auszug						
			400	DBUS S C 040	●●●										
			600	DBUS S C 060	●●●										
			800	DBUS S C 080	●●●										
		350-450	300-800	DBUS S C XXX	●●●										
	536	390	300	DBUS S D 030	●●●				Unterschrank 2 Auszüge						
			400	DBUS S D 040	●●●										
			600	DBUS S D 060	●●●										
			800	DBUS S D 080	●●●										
		350-450	300-800	DBUS S D XXX	●●●										
	536	390	300	DBUS S E 030	●				Unterschrankregal 1 verstellbarer Holzfachboden						
			400	DBUS S E 040	●										
		160-450	300-400	DBUS S E XXX	●										
	780	260	300	DBOS S A 030 L DBOS S A 030 R	●●●				Oberschrank 1 Tür 2 verstellbare Glasfachböden						
			400	DBOS S A 040 L DBOS S A 040 R	●●●										
		250-450	300-400	DBOS S A XXX L DBOS S A XXX R	●●●								1 Tür 2 verstellbare Holzfachböden		
	780	260	300	DBOS S B 030	●				Oberschrankregal 2 verstellbare Holzfachböden						
			400	DBOS S B 040	●										
		160-450	300-400	DBOS S B XXX	●										

	Höhe in mm	Tiefe in mm	Breite in mm	Type	Griff Korpus Front	Preisgruppen			Beschreibung	
						1	2	3		
	1186	390	300	DBHB S A 030 L DBHB S A 030 R	●●●				Highboard 1 Tür 3 verstellbare Glasfachböden	
			400	DBHB S A 040 L DBHB S A 040 R	●●●					
	1186	390	300	300-400	DBHB S A XXX L DBHB S A XXX R	●●●				1 Tür 3 verstellbare Holzfachböden
				300-400	DBHB S D 030 L DBHB S D 030 R	●●●				
	1186	390	300	DBHB S B 030 L DBHB S B 030 R	●●●				Highboard 1 Tür 1 verstellbarer Glasfachboden 2 Schubladen 1 Auszug	
			400	DBHB S B 040 L DBHB S B 040 R	●●●					
	1186	390	300	300-400	DBHB S D 040 L DBHB S D 040 R	●●●				1 Tür mit Innenspiegel 2 verstellbare Glasfachböden 1 Innenschublade
				300-400	DBHB S B XXX L DBHB S B XXX R	●●●				
	1186	390	600	DBHB S C 060	●●●				Highboard 2 Türen 1 verstellbarer Glasfachboden 2 Schubladen 1 Auszug	
			800	DBHB S C 080	●●●					
	1186	390	600-800	600-800	DBHB S C XXX	●●●				2 Türen 1 verstellbarer Holzfachboden 2 Schubladen 1 Auszug
				600-800	DBHB S C XXX	●●●				
	1186	390	300	DBHB S E 030	●				Highboardregal 3 verstellbare Holzfachböden	
			400	DBHB S E 040	●					
	1186	390	300-400	300-400	DBHB S B XXX	●				
				300-400	DBHB S B XXX	●				
	25	160	300	DBWB 030	●				Wandboard mit Befestigungsbeschlag Kunststoff in Korpusdekor mit Dickkante	
			400	DBWB 040	●					
			500	DBWB 050	●					
			600	DBWB 060	●					
			700	DBWB 070	●					
			800	DBWB 080	●					
			900	DBWB 090	●					
			1000	DBWB 100	●					
			1200	DBWB 120	●					
			1300	DBWB 130	●					
			1400	DBWB 140	●					
			1600	DBWB 160	●					

Ablage Aluminium pulverbeschichtet



schwarz RAL 9005

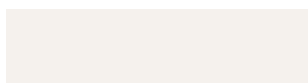

weiß RAL 9016







feuerrot RAL 3000

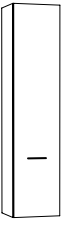
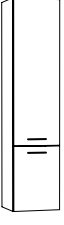
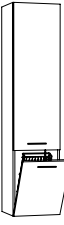
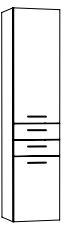

anthrazit

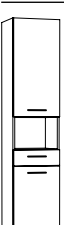
	150	100	350	Z AA S	●				Ablage Aluminium Aluminium pulverbeschichtet wird an Ablagebord geschraubt
				Z AA W	●				schwarz RAL 9005
				Z AA F	●				weiß RAL 9016
				Z AA A	●				feuerrot RAL 3000
									anthrazit

	Höhe in mm	Tiefe in mm	Breite in mm	Type	Griff Korpus Front	Preisgruppen			Beschreibung
						1	2	3	
	1690	390	300	DBHS S A 030 L DBHS S A 030 R	●●●				Hochschrank 1 Tür 4 verstellbare Glasfachböden
			400	DBHS S A 040 L DBHS S A 040 R	●●●				
		250-450	300-400	DBHS S A XXX L DBHS S A XXX R	●●●				
	1690	390	300	DBHS S B 030 L DBHS S B 030 R	●●●				Hochschrank 2 Türen 4 verstellbare Glasfachböden
			400	DBHS S B 040 L DBHS S B 040 R	●●●				
		250-450	300-400	DBHS S B XXX L DBHS S B XXX R	●●●				
	1690	390	300	DBHS S C 030 L DBHS S C 030 R	●●●				Hochschrank 1 Tür 3 verstellbare Glasfachböden 1 Klapptür mit Wäschekorb
			400	DBHS S C 040 L DBHS S C 040 R	●●●				
		350-450	300-400	DBHS S C XXX L DBHS S C XXX R	●●●				
	1690	390	300	DBHS S D 030 L DBHS S D 030 R	●●●				Hochschrank 2 Türen 3 verstellbare Glasfachböden 2 Schubladen
			400	DBHS S D 040 L DBHS S D 040 R	●●●				
		350-450	300-400	DBHS S D XXX L DBHS S D XXX R	●●●				
	1690	390	300	DBHS S E 030 L DBHS S E 030 R	●●●				Hochschrank 2 Türen 3 verstellbare Glasfachböden 3 Schubladen
			400	DBHS S E 040 L DBHS S E 040 R	●●●				
		350-450	300-400	DBHS S E XXX L DBHS S E XXX R	●●●				
	1690	390	300	DBHS S F 030 L DBHS S F 030 R	●●●				Hochschrank 2 Türen 3 verstellbare Glasfachböden 1 offenes Fach 1 Schublade
			400	DBHS S F 040 L DBHS S F 040 R	●●●				
		350-450	300-400	DBHS S F XXX L DBHS S F XXX R	●●●				

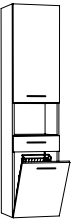
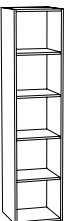
	Höhe in mm	Tiefe in mm	Breite in mm	Type	Griff Korpus Front	Preisgruppen			Beschreibung
						1	2	3	
	1690	390	300	DBHS S G 030 L DBHS S G 030 R	●●●				Hochschrank 1 Tür 2 verstellbare Glasfachböden 3 Schubladen 1 Klapptür mit Wäschekorb
			400	DBHS S G 040 L DBHS S G 040 R	●●●				
		T B	350-450	300-400	DBHS S G XXX L DBHS S G XXX R				
	1690	390	300	DBHS S H 030 L DBHS S H 030 R	●●●				Hochschrank 1 Tür 2 verstellbare Glasfachböden 1 offenes Fach 1 Schublade 1 Klapptür mit Wäschekorb
			400	DBHS S H 040 L DBHS S H 040 R	●●●				
		T B	350-450	300-400	DBHS S H XXX L DBHS S H XXX R				
	1690	390	300	DBHS S I 030	●				Hochschrankregal 4 verstellbare Holzfachböden
			400	DBHS S I 040	●				
		T B	160-450	300-400	DBHS S I XXX				



dimara® Leuchtspiegel – Beleuchtung wählbar

	Höhe in mm	Tiefe in mm	Breite in mm	Type	Korpus	Preis	Beschreibung
	780	45	600	DSLS 060	●		Flächenspiegel Inkl. Lichtschalter und Netzteil
			700	DSLS 070	●		
			800	DSLS 080	●		
			900	DSLS 090	●		
			1000	DSLS 100	●		
			1200	DSLS 120	●		
			1300	DSLS 130	●		
			1400	DSLS 140	●		
			1600	DSLS 160	●		
			1800	DSLS 180	●		

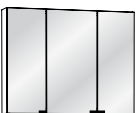
dimara® Spiegelschränke – Beleuchtung wählbar

	Höhe in mm	Tiefe in mm	Breite in mm	Type	Korpus	Preis	Beschreibung
	780	160	600	DSSS S A 060	●		Spiegelschrank 1 Lichtschalter, 1 Steckdose und Netzteil 1 Magnetleiste, 1 Utensilienbox 1 Kosmetikspiegel zum Aufkleben verchromte Griffe zum Aufkleben 2 Türen, 2 Glasfachböden
			700	DSSS S A 070	●		
			800	DSSS S A 080	●		
			900	DSSS S A 090	●		
	780	160	1000	DSSS S A 100	●		3 Türen, 4 Glasfachböden
			1200	DSSS S A 120	●		
			1300	DSSS S A 130	●		

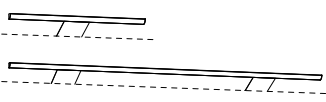
dimara® wählbare Beleuchtung

	45	100	200	DSAS 020 AL			LED-Flächenleuchte weiß Energieeffizienzklasse A LED 12 V / 6 W, 4000 K, 340 Lumen
	50	80	455	DSAS 050 ST			LED 12 V / 5,4 W, 4000 K, 405 Lumen
			755	DSAS 080 ST			LED 12 V / 9 W, 4000 K, 675 Lumen
			1155	DSAS 115 ST			LED 12 V / 13,8 W, 4000 K, 1035 Lumen
	10	250	600	DSBB 060 L			LED 12 V / 6,9 W, 4000 K, 517 Lumen
			700	DSBB 070 L			LED 12 V / 8,1 W, 4000 K, 607 Lumen
			800	DSBB 080 L			LED 12 V / 9,3 W, 4000 K, 697 Lumen
			900	DSBB 090 L			LED 12 V / 10,5 W, 4000 K, 787 Lumen
			1000	DSBB 100 L			LED 12 V / 11,7 W, 4000 K, 877 Lumen
			1200	DSBB 120 L			LED 12 V / 14,1 W, 4000 K, 1057 Lumen
			1300	DSBB 130 L			LED 12 V / 15,3 W, 4000 K, 1147 Lumen
	45	70	500	LLS 50			LED 12 V / 4,6 W, 4000 K, ca. 400 Lumen
			600	LLS 60			LED 12 V / 6,4 W, 4000 K, ca. 500 Lumen
			800	LLS 80			LED 12 V / 7,4 W, 4000 K, ca. 680 Lumen
			900	LLS 90			LED 12 V / 8,4 W, 4000 K, ca. 750 Lumen
			1000	LLS 100			LED 12 V / 9,3 W, 4000 K, ca. 850 Lumen
			1200	LLS 120			LED 12 V / 11 W, 4000 K, ca. 1020 Lumen
			1300	LLS 130			LED 12 V / 12,2 W, 4000 K, ca. 1100 Lumen
			1400	LLS 140			LED 12 V / 13 W, 4000 K, ca. 1190 Lumen
			1500	LLS 150			LED 12 V / 14,1 W, 4000 K, ca. 1280 Lumen
			1600	LLS 160			LED 12 V / 14,9 W, 4000 K, ca. 1360 Lumen
1800	LLS 180			LED 12 V / 16,8 W, 4000 K, ca. 1530 Lumen			

dimara® Spiegelschränke „PLUS“

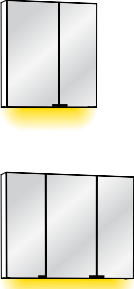
	Höhe in mm	Tiefe in mm	Breite in mm	Type	Korpus	Preis	Beschreibung	
	780	160	600	DSSS S B 060	●		Spiegelschrank mit beleuchtetem Griffprofil für Innen- und Außenbeleuchtung, Energieeffizienzklasse A Farbtemperaturwechsel von coolwhite auf warmwhite 1 Lichtschalter, 2 Steckdosen und Netzteil 1 Magnetleiste, 1 Utensilienbox 1 Kosmetikspiegel zum Aufkleben verchromte Griffe zum Aufkleben 2 Türen, 2 Glasfachböden LED 12 V / 10,6 W, 6500-3250 K, 396 Lumen LED 12 V / 12,5 W, 6500-3250 K, 468 Lumen LED 12 V / 14,4 W, 6500-3250 K, 540 Lumen LED 12 V / 16,3 W, 6500-3250 K, 612 Lumen	
			700	DSSS S B 070	●			
			800	DSSS S B 080	●			
			900	DSSS S B 090	●			
	780	160	1000	DSSS S B 100	●			3 Türen, 4 Glasfachböden LED 12 V / 18,2 W, 6500-3250 K, 684 Lumen LED 12 V / 22,1 W, 6500-3250 K, 828 Lumen LED 12 V / 24 W, 6500-3250 K, 900 Lumen
			1200	DSSS S B 120	●			
			1300	DSSS S B 130	●			

dimara® Beleuchtung für Spiegelschränke „PLUS“

	Höhe in mm	Tiefe in mm	Breite in mm	Type	Korpus	Preis	Beschreibung
	10	250	600	DSBB 060 F			LED-Beleuchtungsboden Farbtemperaturwechsel Energieeffizienzklasse A LED 12 V / 11 W, 6500-3250 K, 414 Lumen LED 12 V / 13 W, 6500-3250 K, 486 Lumen LED 12 V / 14,9 W, 6500-3250 K, 558 Lumen LED 12 V / 16,8 W, 6500-3250 K, 630 Lumen LED 12 V / 18,7 W, 6500-3250 K, 702 Lumen LED 12 V / 22,6 W, 6500-3250 K, 846 Lumen LED 12 V / 24,5 W, 6500-3250 K, 918 Lumen
			700	DSBB 070 F			
			800	DSBB 080 F			
			900	DSBB 090 F			
			1000	DSBB 100 F			
			1200	DSBB 120 F			
			1300	DSBB 130 F			

Weitere Leuchtspiegel siehe Seite 8+9

Kompaktwaschtisch Mineralguß

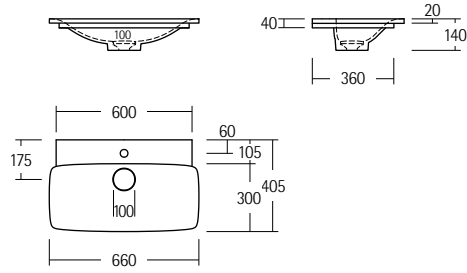

Einzelwaschtisch Mineralguß

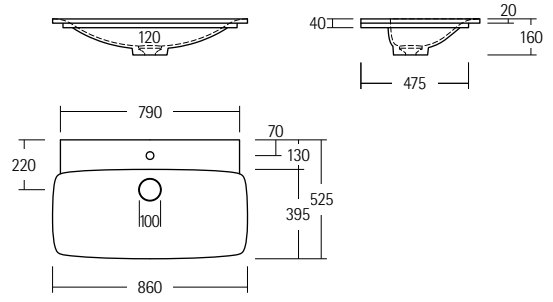

Einzelwaschtisch mit Verlängerung Mineralguß

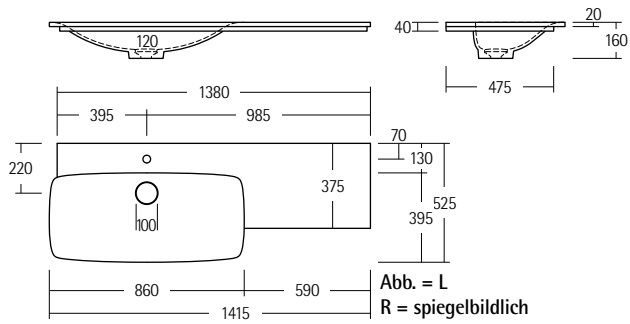

Doppelwaschtisch Mineralguß

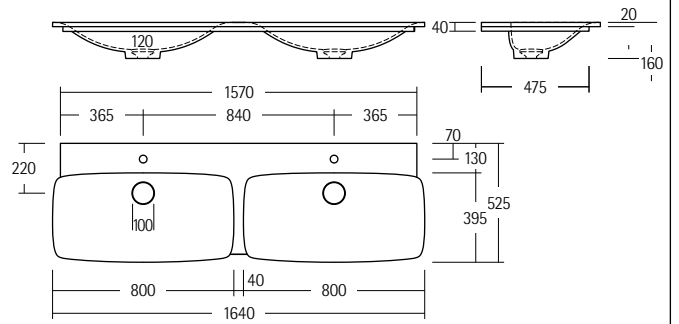

Montageanleitung: www.dirano.de → Service → Downloads

Waschtisch-Unterschranke

Alle Maße in mm

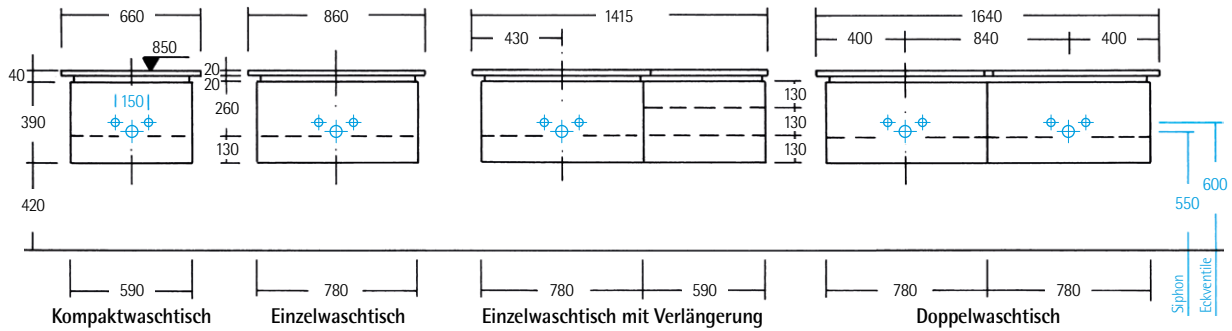

Spiegelschränke und Beimöbel

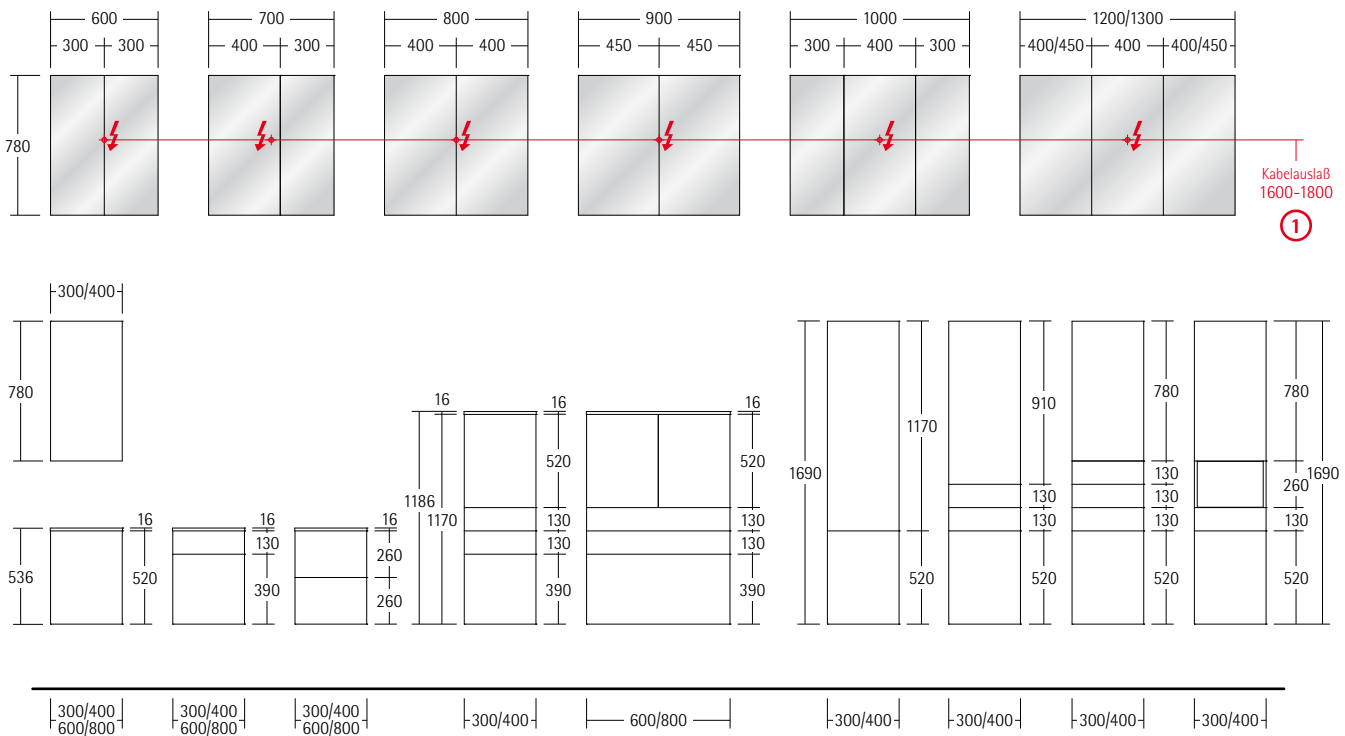

Elektro- und Wasserinstallationen dürfen nur von autorisierten Fachhandwerkern vorgenommen werden!